

OR

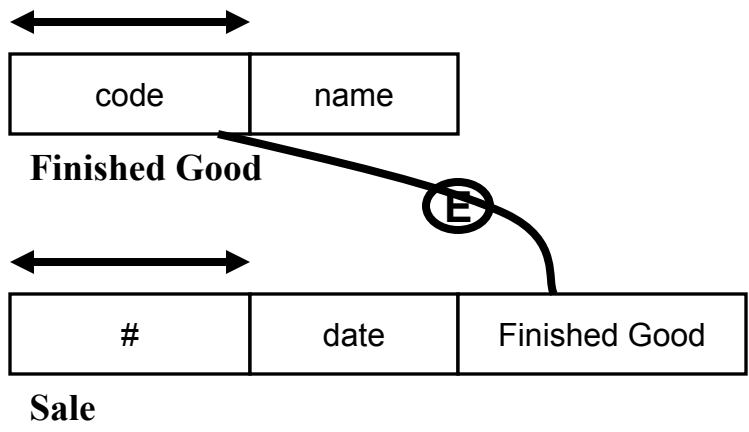

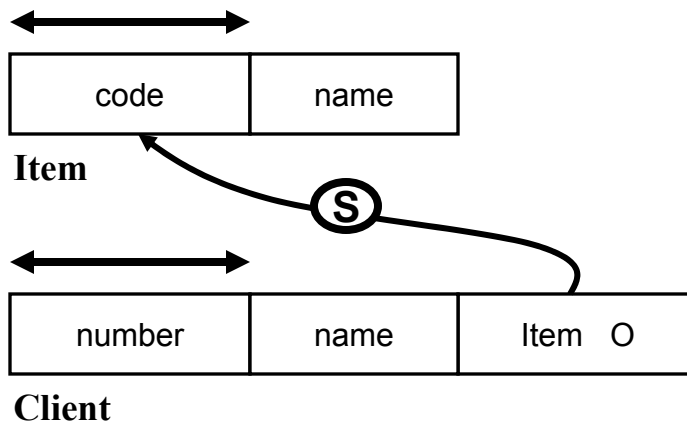

# Correct Relational Database Structure (Do not change the cardinalities!)

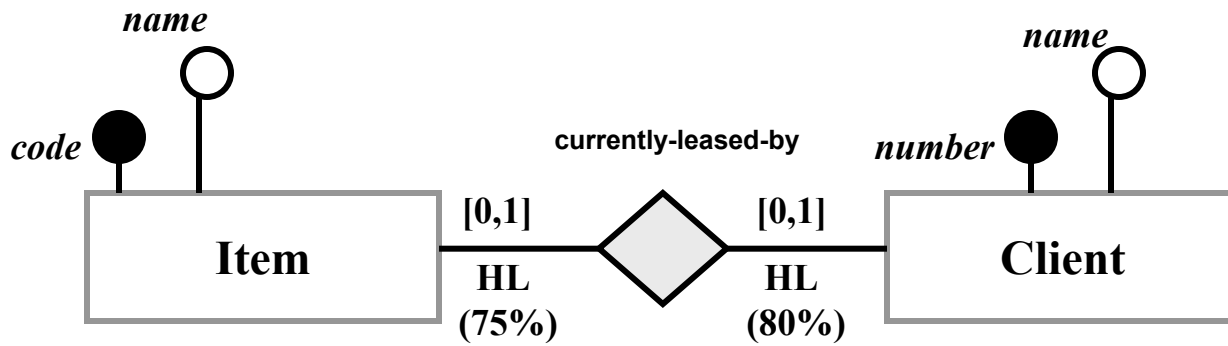
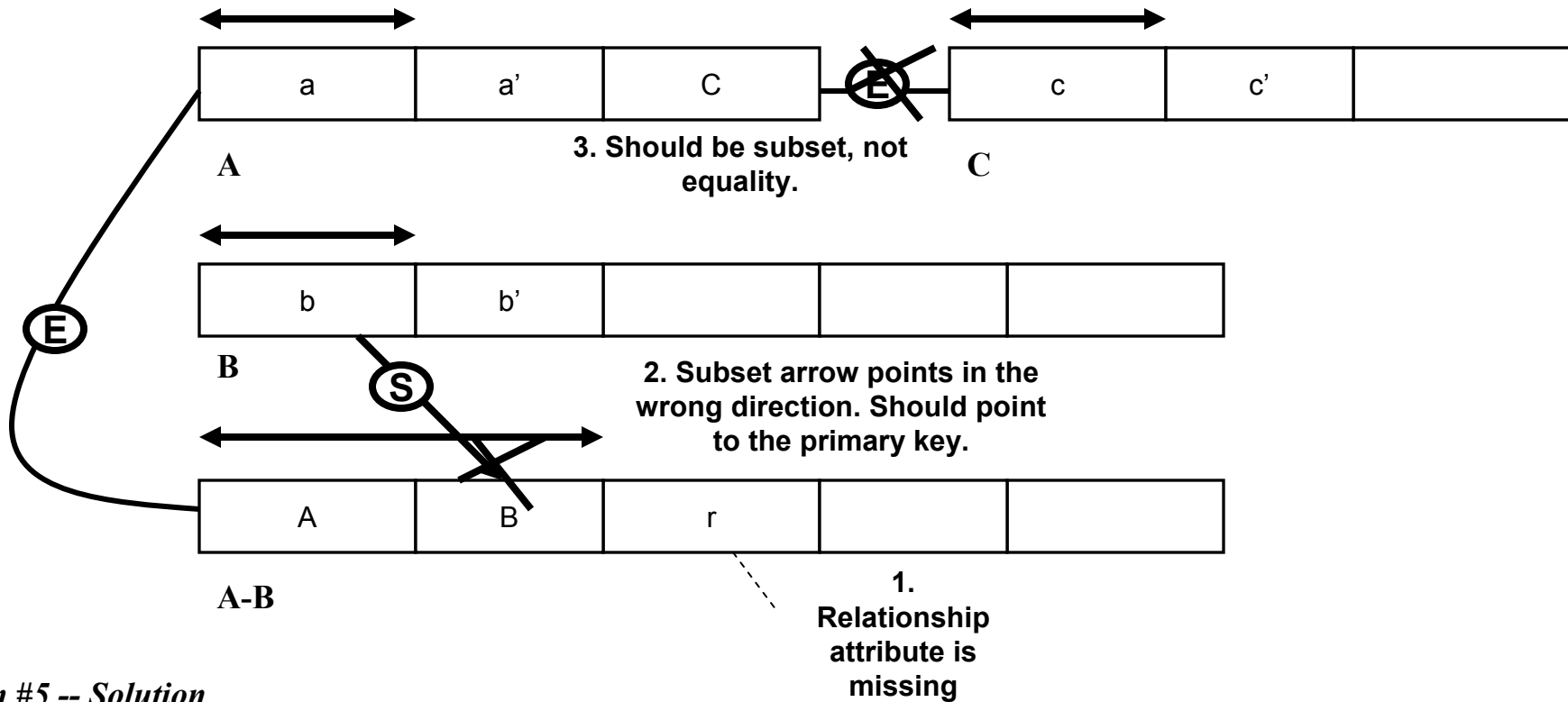
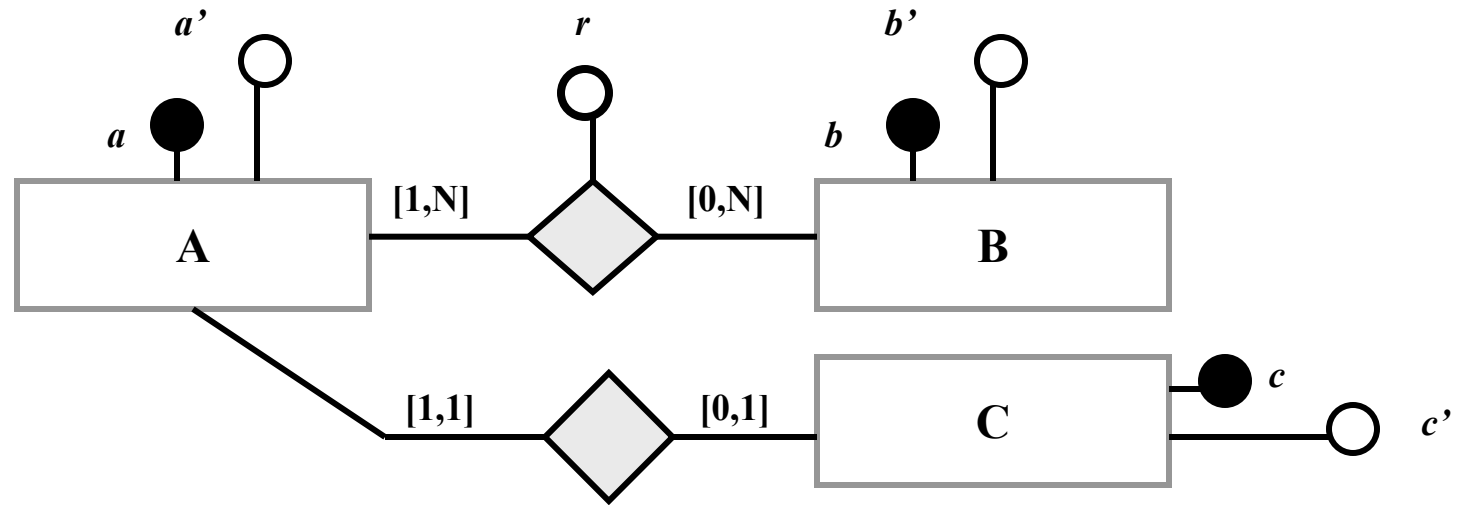

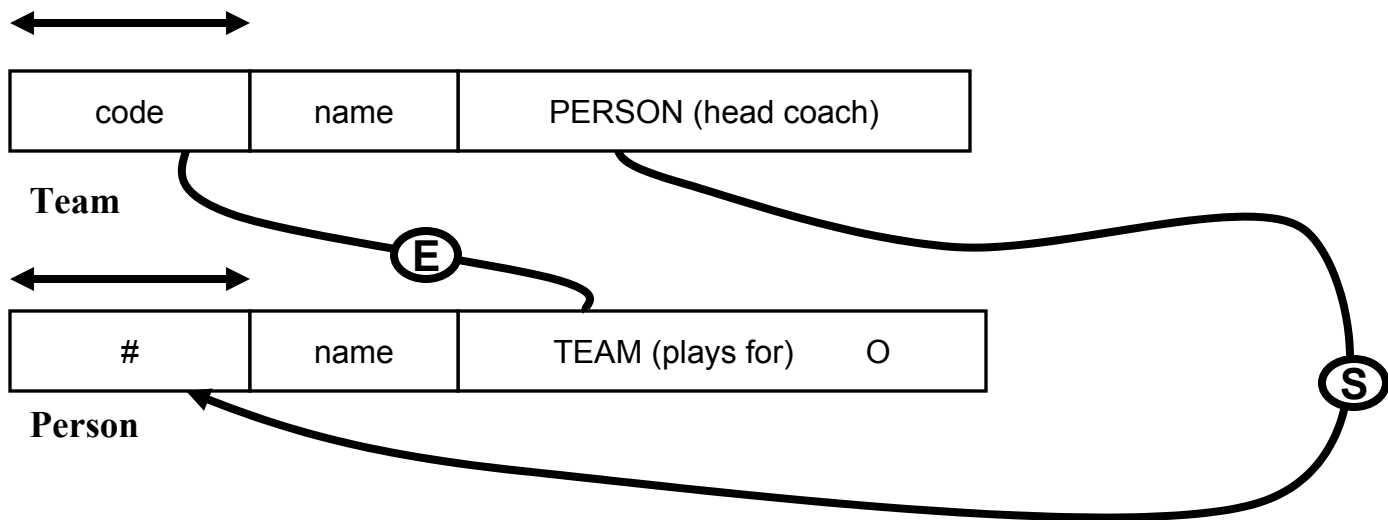
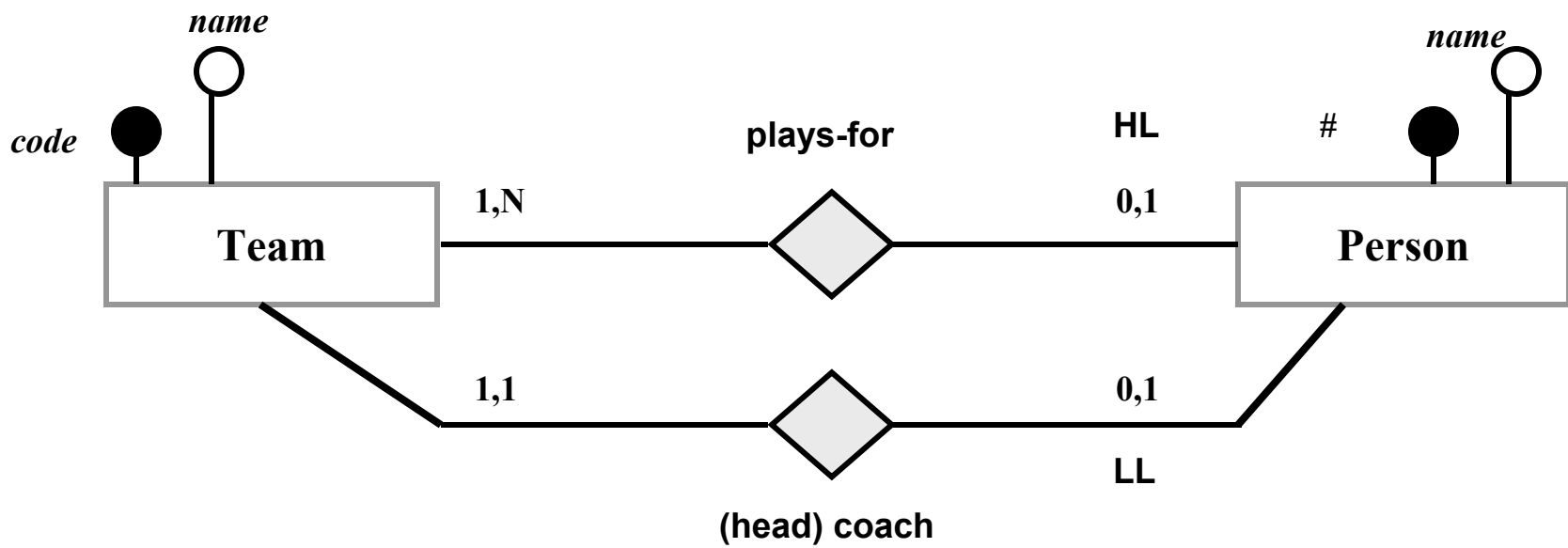

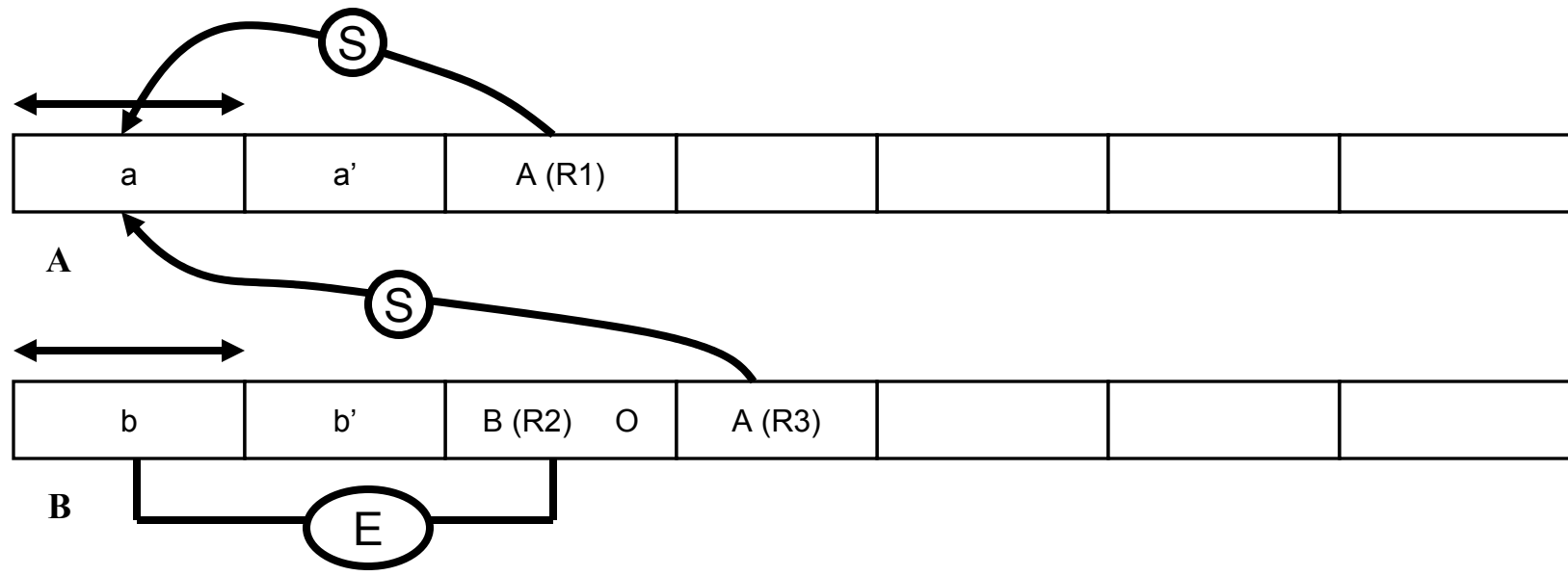
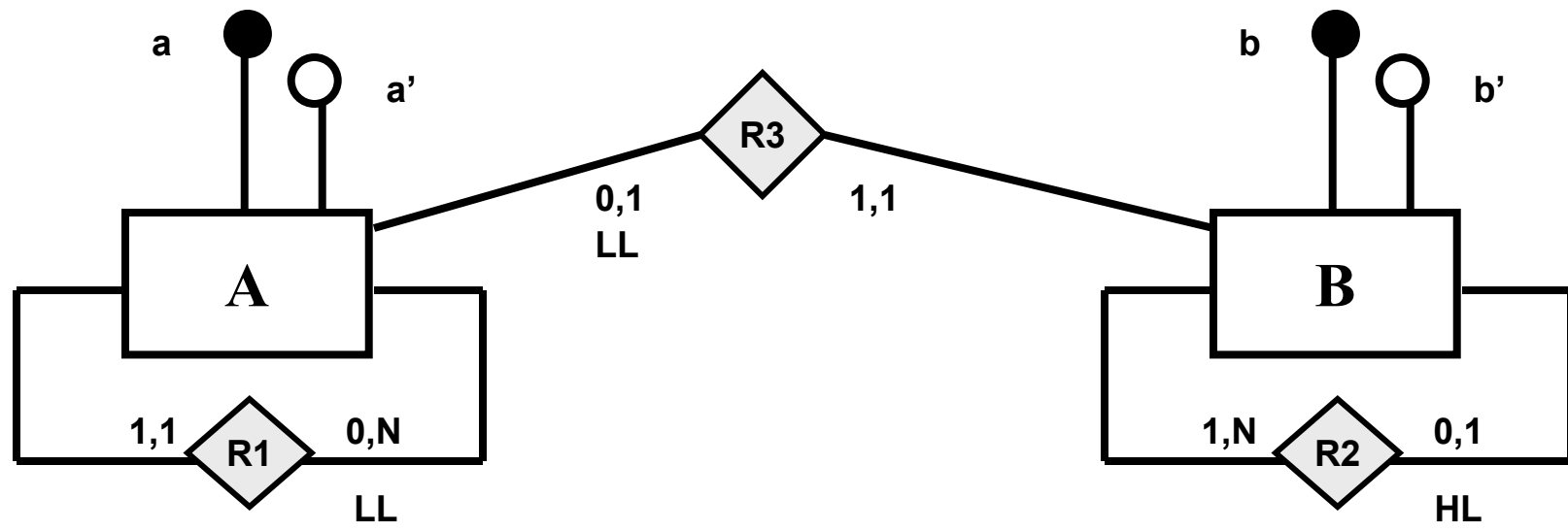

*Problem #7 -- Solution*